



McIntosh Laboratory, Inc. 2 Chambers Street Binghamton, New York 13903-2699 Phone: 607-723-3512 www.mcintoshlabs.com

MCD550
SACD/CD Player
Owner's Manual



The lightning flash with arrowhead, within an equilateral triangle, is intended to alert the user to the presence of uninsulated "dangerous voltage" within the product's enclosure that may be of sufficient magnitude to constitute a risk of electric shock to persons.

WARNING - TO REDUCE RISK OF FIRE OR ELECTRICAL SHOCK, DO NOT EXPOSE THIS EQUIPMENT TO RAIN OR MOISTURE.



AVIS RISQUE DE CHOC ELECTRIQUE - NE PAS OUVRIR.

NO USER-SERVICEABLE PARTS INSIDE. REFER SERVICING TO QUALIFIED PERSONNEL.

The exclamation point within an equilateral triangle is intended to alert the user to the presence of important operating and maintenance (servicing) instructions in the literature accompanying the appliance.

To prevent the risk of electric shock, do not remove cover or back. No user-serviceable parts inside.

CAUTION - Invisible Laser Radiation when open. DO NOT stare into the beam or view directly with optical instruments. Use of controls or adjustments or performance of procedures other than those specified in the Owners Manual may result in Hazardous Radiation Exposure.

**LUOKAN 1 LASERLAITE
KLASS 1 LASER APPARAT**

VAROITUS! Laitteen käyttäminen muulla kuin tassa käyttöohjeessa mainitulla tavalla saattaa altistaa käyttäjän turvallisuusluokan 1 ylittävälle näkymättömälle lasersäteilylle.

WARNING! Om apparaten används på annat sätt än i denna bruksanvisning specificerats, kan användaren utsättas för osynlig laserstrålning, som överstiger gränsen för laserklass 1.

This product incorporates an embedded **CLASS 3R Laser (IEC60825-1).**

CAUTION: CLASS 3R INVISIBLE LASER RADIATION WHEN OPEN, DO NOT STARE INTO THE BEAM OR VIEW DIRECTLY WITH OPTICAL INSTRUMENTS. AVOID DIRECT EYE EXPOSURE.

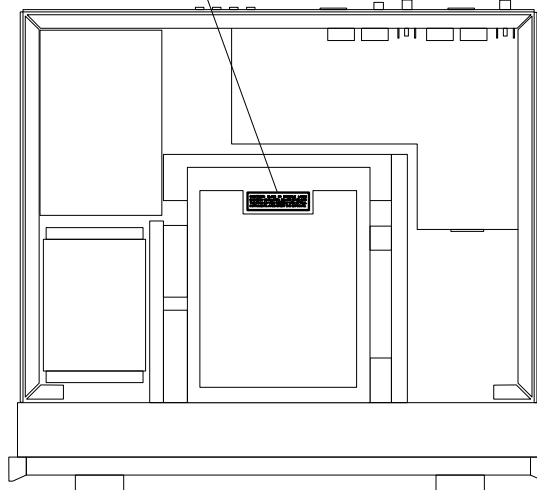

**CLASS 1
LASER PRODUCT**

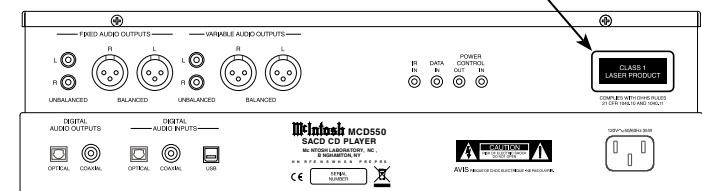

IMPORTANT SAFETY INSTRUCTIONS!

PLEASE READ THEM BEFORE OPERATING THIS EQUIPMENT.

1. Read these instructions.
2. Keep these instructions.
3. Heed all warnings.
4. Follow all instructions.
5. Do not use this apparatus near water.
6. Clean only with a dry cloth.
7. Do not block any ventilation openings. Install in accordance with the manufacturer's instructions.
8. Do not install near any heat sources such as radiators, heat registers, stoves, or other apparatus (including amplifiers) that produce heat.
9. Do not defeat the safety purpose of the polarized or grounding-type plug. A polarized plug has two blades with one wider than the other. A grounding type plug has two blades and a third grounding prong. The wide blade or the third prong are provided for your safety. If the provided plug does not fit into your outlet, consult an electrician for replacement of the obsolete outlet.
10. Protect the power cord from being walked on or pinched particularly at plugs, convenience receptacles, and the point where they exit from the apparatus.
11. Only use attachments/accessories specified by the manufacturer.

12. Use only with the cart, stand, tripod, bracket, or table specified by the manufacturer, or sold with the apparatus. When a cart is used, use caution when moving the cart/apparatus combination to avoid injury from tip-over.
13. Unplug this apparatus during lightning storms or when unused for long periods of time.
14. Refer all servicing to qualified service personnel. Servicing is required when the apparatus has been damaged in any way, such as power-supply cord or plug is damaged, liquid has been spilled or objects have fallen into the apparatus, the apparatus has been exposed to rain or moisture, does not operate normally, or has been dropped.
15. Do not expose this equipment to dripping or splashing and ensure that no objects filled with liquids, such as vases, are placed on the equipment.
16. To completely disconnect this equipment from the a.c. mains, disconnect the power supply cord plug from the a.c. receptacle.
17. The mains plug of the power supply cord shall remain readily operable.
18. Do not expose batteries to excessive heat such as sunshine, fire or the like.
19. Connect mains power supply cord only to a mains socket outlet with a protective earthing connection.



Table of Contents

Safety Instructions	2-3
Table of Contents	3
Thank You and Please Take a Moment.....	4
Technical Assistance and Customer Service	4
General Information	4
Connector and Cable Information	4
Disc Information	5
Introduction.....	5
Performance Features	5
Dimensions	6
Installation	7

Connections:

Rear Panel Connections	8
MCD550 Connections.....	10
Connection Diagrams (Separate Sheet).....	Mc1A
MCD550 Direct to Power Amplifier Connections ...	11
Connection Diagram (Separate Sheet).....	Mc1B

Front Panel Features:

Front Panel Displays, Controls, Push-buttons and Jack.....	12
Front Panel Displays	13

Remote Control:

Remote Control Push-buttons.....	14
How to use the Remote Control.....	15

Operation:

How to Operate the MCD550	16-22
---------------------------------	-------

Additional Information:

Photos.....	23-25
Specifications.....	26
Packing Instruction.....	27



Thank You

Your decision to own this McIntosh MCD550 SACD/CD Player ranks you at the very top among discriminating music listeners. You now have “The Best.” The McIntosh dedication to “Quality,” is assurance that you will receive many years of musical enjoyment from this unit.

Please take a short time to read the information in this manual. We want you to be as familiar as possible with all the features and functions of your new McIntosh.

Please Take A Moment

The serial number, purchase date and McIntosh Dealer name are important to you for possible insurance claim or future service. The spaces below have been provided for you to record that information:

Serial Number: _____

Purchase Date: _____

Dealer Name: _____

Technical Assistance

If at any time you have questions about your McIntosh product, contact your McIntosh Dealer who is familiar with your McIntosh equipment and any other brands that may be part of your system. If you or your Dealer wish additional help concerning a suspected problem, you can receive technical assistance for all McIntosh products at:

McIntosh Laboratory, Inc.
2 Chambers Street
Binghamton, New York 13903
Phone: 607-723-1545
Fax: 607-724-0549

Customer Service

If it is determined that your McIntosh product is in need of repair, you can return it to your Dealer. You can also return it to the McIntosh Laboratory Service Department. For assistance on factory repair return procedure, contact the McIntosh Service Department at:

McIntosh Laboratory, Inc.
2 Chambers Street
Binghamton, New York 13903
Phone: 607-723-3515
Fax: 607-723-1917

General Information

1. For additional connection information, refer to the owner’s manual(s) for any component(s) connected to the MCD550 SACD/CD Player.
2. The Super Audio Compact Discs Audio Signals are converted internally from Digital to Analog. There is no Digital Audio Signal present at the MCD550 Digital Output Connectors during playback of a SACD Disc.
3. A PCM version of the decoded MP3 and WMA Signals is available at the Digital Audio Outputs.
4. The MCD550 internal Digital to Analog Converter is designed to decode 2 channel PCM (Pulse Code Modulation) signal present at the Digital Audio Inputs into 2 channel analog audio.
5. The IR Input, with a 3.5mm mini phone jack, is configured for non-McIntosh IR sensors such as a Xantech Model HL85BK Kit. Use a Connection Block such as a Xantech Model ZC21 when two or more IR sensors need to be connected to the MCD550.
5. When discarding the unit, comply with local rules or regulations. Batteries should never be thrown away or incinerated but



disposed of in accordance with the local regulations concerning battery disposal.

6. For additional information on the MCD550 and other McIntosh Products please visit the McIntosh Web Site at www.mcintoshlabs.com.

Connector and Cable Information

XLR Connectors

Below is the Pin configuration for the XLR Balanced Output Connectors on the MCD550. Refer to the diagram for connection:

- PIN 1: Shield/Ground
- PIN 2: + Output
- PIN 3: - Output

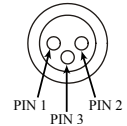

Data and IR Input Port Connectors

The MCD550 Data In Port receives Remote Control Signals. A 1/8 inch stereo mini phone plug is used for connection. The IR Ports also use a 3.5mm stereo mini phone plug and allow the connection of other brand IR Receivers to the MCD550.

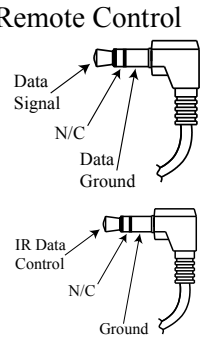

Power Control Connector

The Power Control Input Jack receives Power On/Off Signals (+12 volt/0 volt) when connected to other McIntosh Components. The Power Control Output Jack sends Power On/Off Signals (+12 volt/0 volt) when connected to other McIntosh Components. An additional connection is for

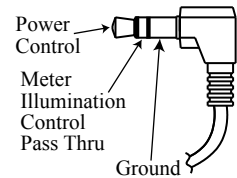

controlling the illumination of the Power Output Meters on McIntosh Power Amplifiers. A 3.5mm stereo mini phone plug is used for connection to the Power Control Jacks.

Disc Information

1. The MCD550 is designed to play round Compact Discs do not try other shapes or possible damage may occur.
2. The MCD550 SACD/CD Player is designed to play all industry standard “Redbook” CD Audio Discs as indicated by the  Symbol. It will also play most CD-R, CD-RW and Dual Discs, however some recorded discs may not be able to play due to the condition of the recording or manufacturing.
3. Disc with tracks recorded with MP3 and WMA Formats will playback on the MCD550 when the writing software used to create them conforms to the ISO9660 Level 1 standard.
4. Several of the SACD performance features available on the MCD550 are active only if the SACD Disc includes the supporting encoded information.
5. The Audio from playback of SACD Two Channel Layer and Multichannel Layer Discs is available at the MCD550 Analog Output Jacks and Connectors; the Digital Outputs will be muted.

Introduction

The McIntosh MCD550 SACD/CD Player offers the latest in audio technology, providing state of the art reproduction of audio program sources. A full complement of performance features allows for the enjoyment of the SACD special audio format available on discs. Audio CDs are also reproduced with flawless realism. The advanced mechanical design of the transport ensures many years of smooth trouble free operation.

Performance Features

• Twin Laser Pickup

The MCD550 incorporates two laser elements, with different wavelengths, that are focused through one lens assembly. This unique design allows reading both the CD and Super Audio Compact Disc (SACD) Discs Formats.

• Advanced Transport

The MCD550 has a new transport with a Die Cast Tray. It has the latest in advanced digital servo for faster, quieter and accurate operation. The Disc Audio Data is read at twice the normal rate insuring better disc tracking and error correction processing.

• Quad Balanced Digital to Analog Converter

The 8 channel 32-bit, 192kHz Digital to Analog Converter is used in a Stereo Quad Balanced Mode, assuring the music is reproduced with a wide dynamic range and extremely low distortion, for both Disc and external sources.

• Digital Audio Inputs and Outputs

The MCD550 has Digital Coaxial and Optical Inputs/Outputs along with an USB Input Connection.

• Front Panel Level Control

The Level Control allows varying the music volume level with headphones, matching the volume level of the MCD550 with other components in a system and can drive any Power Amplifier directly.

• Power Control and Full Function Remote Control

The Power Control Input Connection switches the MCD550 On/Off with other McIntosh Components in a system. The Remote Control with illuminated push-buttons provides complete control of the MCD550

operating functions.

• Multi-Function Front Panel Display

The MCD550 Front Panel display indicates the current disc playback status, digital input status and the variable audio output volume level.

• Balanced Outputs

The MCD550 has both variable and fixed Balanced Outputs, permitting long cable lengths without a loss in sound quality.

• Special Power Supply

The Linear Power Supply has both a special R-Core Power Transformer and Multiple Regulators to ensure stable noise free operation even though the power line varies.

• Glass Front Panel and Super Mirror Chassis

The MCD550 has the famous McIntosh Illuminated Glass Front Panel and Stainless Steel Super Mirror Finish Chassis ensures the pristine beauty of the MCD550 will be retained for many years.

• Fiber Optic Solid State Front Panel Illumination

The Illumination of the Front Panel is accomplished by the combination of custom designed Fiber Optic Light Diffusers and extra long life Light Emitting Diodes (LEDs). This provides even Front Panel Illumination and is designed to ensure the pristine beauty of the MCD550 will be retained for many years.



Dimensions

The following dimensions can assist in determining the best location for your MCD550.

Front View of the MCD550

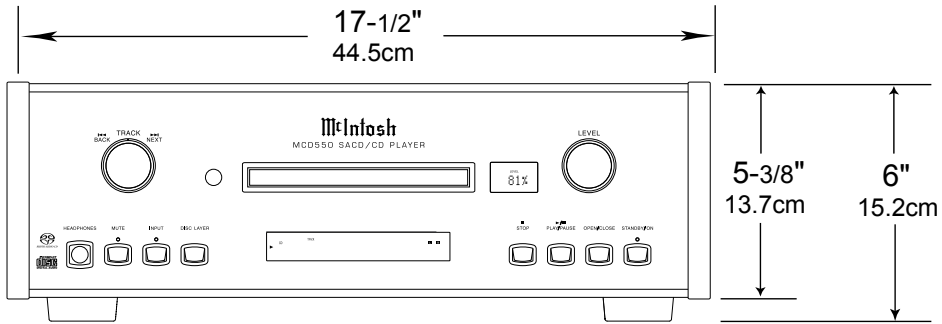

Rear View of the MCD550

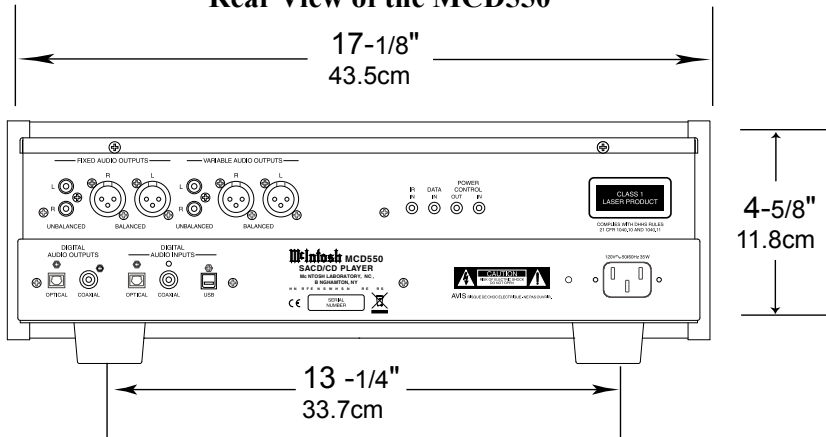

Side View of the MCD550

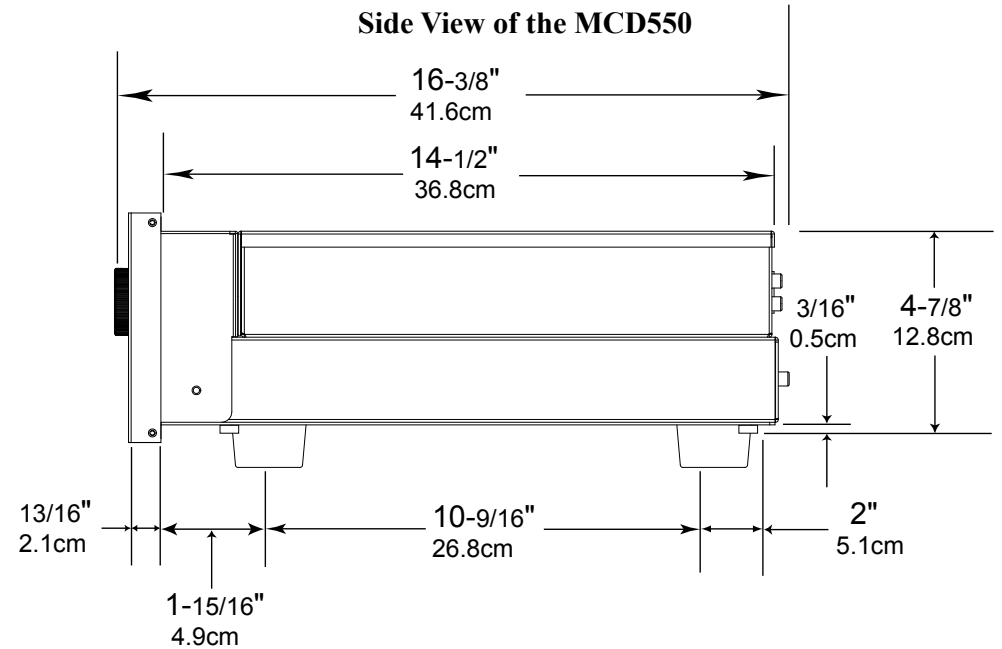

Installation

The MCD550 can be placed upright on a table or shelf, standing on its four feet. It also can be custom installed in a piece of furniture or cabinet of your choice. The four feet may be removed from the bottom of the MCD550 when it is custom installed as outlined below. The four feet together with the mounting screws should be retained for possible future use if the MCD550 is removed from the custom installation and used free standing. The required panel cutout, ventilation cutout and unit dimensions are shown.

Always provide adequate ventilation for your MCD550. Cool operation ensures the longest possible operating life for any electronic instrument. Do not install the MCD550 directly above a heat generating component such as a high powered amplifier. If all the components are installed in a single cabinet, a quiet running ventilation fan can be a definite asset in maintaining all the system components at the coolest possible operating temperature.

A custom cabinet installation should provide the following minimum spacing dimensions for cool operation.

Allow at least 2 inches (5.1cm) above the top, 2 inches (5.1cm) below the bottom and 1 inch (2.5cm) on each side of the SACD/CD Player, so that airflow is not obstructed. Allow 17 inches (43.2cm) depth behind the front panel. Allow 1-1/8 inch (2.9cm) in front of the mounting panel for knob clearance. Be sure to cut out a ventilation hole in the mounting shelf according to the dimensions in the drawing.

**MCD550 Front Panel
Custom Cabinet Cutout**

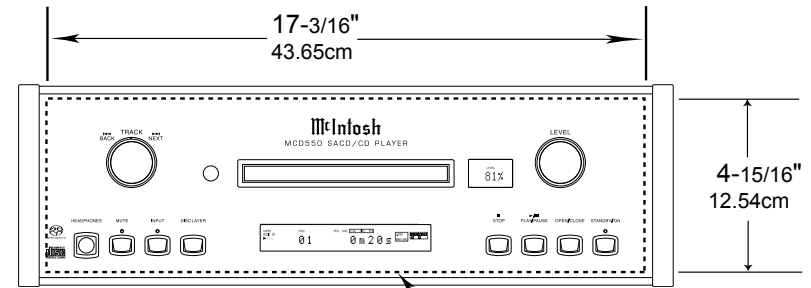

**MCD550 Side View
in Custom Cabinet**

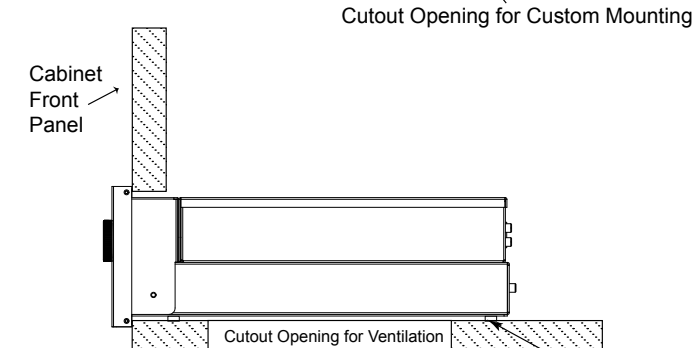

**MCD550 Bottom View
in Custom Cabinet**

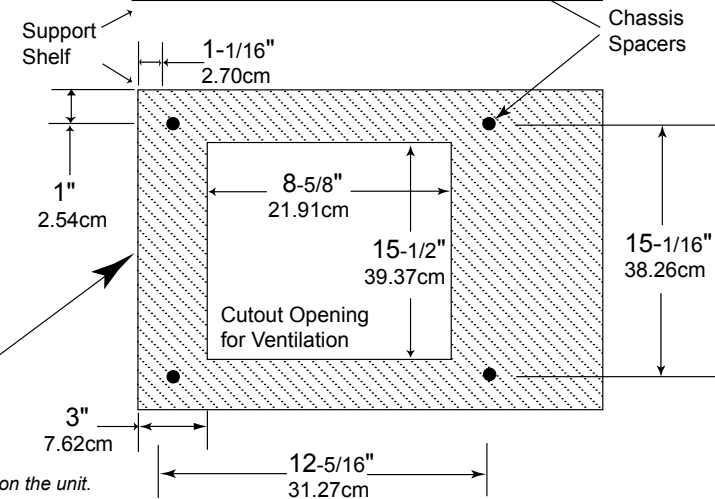

Note: Center the cutout horizontally on the unit.
For purposes of clarity, the above illustration is not drawn to scale.



UNBALANCED FIXED level AUDIO OUTPUTS supply analog audio signals to Unbalanced Inputs of other components

UNBALANCED VARIABLE level AUDIO OUTPUTS supply analog audio signals to Unbalanced Inputs of other components

BALANCED FIXED level AUDIO OUTPUTS supply analog audio signals to Balanced Inputs of other components

BALANCED VARIABLE level AUDIO OUTPUTS supply analog audio signals to connect to Balanced Inputs of other components

POWER CONTROL IN receives turn-on signals from a McIntosh component and POWER CONTROL OUT sends turn-on signals on to another McIntosh Component

Connect the MCD550 power cord to a live AC outlet. Refer to information on the back panel of your MCD550 to determine the correct voltage for your unit

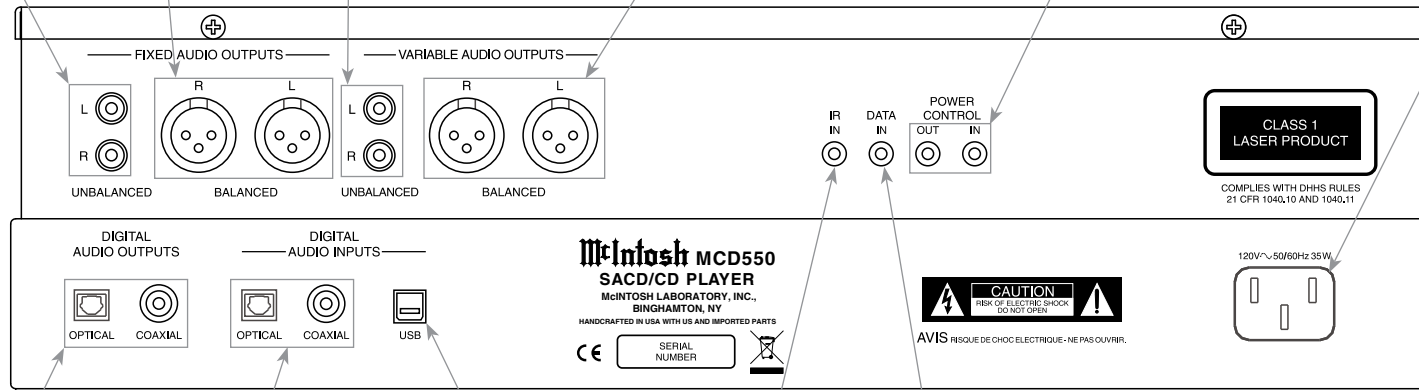

OPTICAL and COAXIAL DIGITAL AUDIO INPUTS receive a Digital Audio Signal¹ from an external source component such as a Disc Player and uses the MCD550 internal D/A Converter to decode the signal into analog audio

IR IN for connecting an IR Receiver

OPTICAL and COAXIAL DIGITAL AUDIO OUTPUTS send a Digital Audio Signal to a Preamp or an A/V Control Center with a D/A Converter or a decoder

USB DIGITAL AUDIO INPUT receives a Digital Audio Signal from a computer connection

DATA IN receives control data from a McIntosh Control Center

¹ - For additional information Refer to page 4 "General Information", note 4.

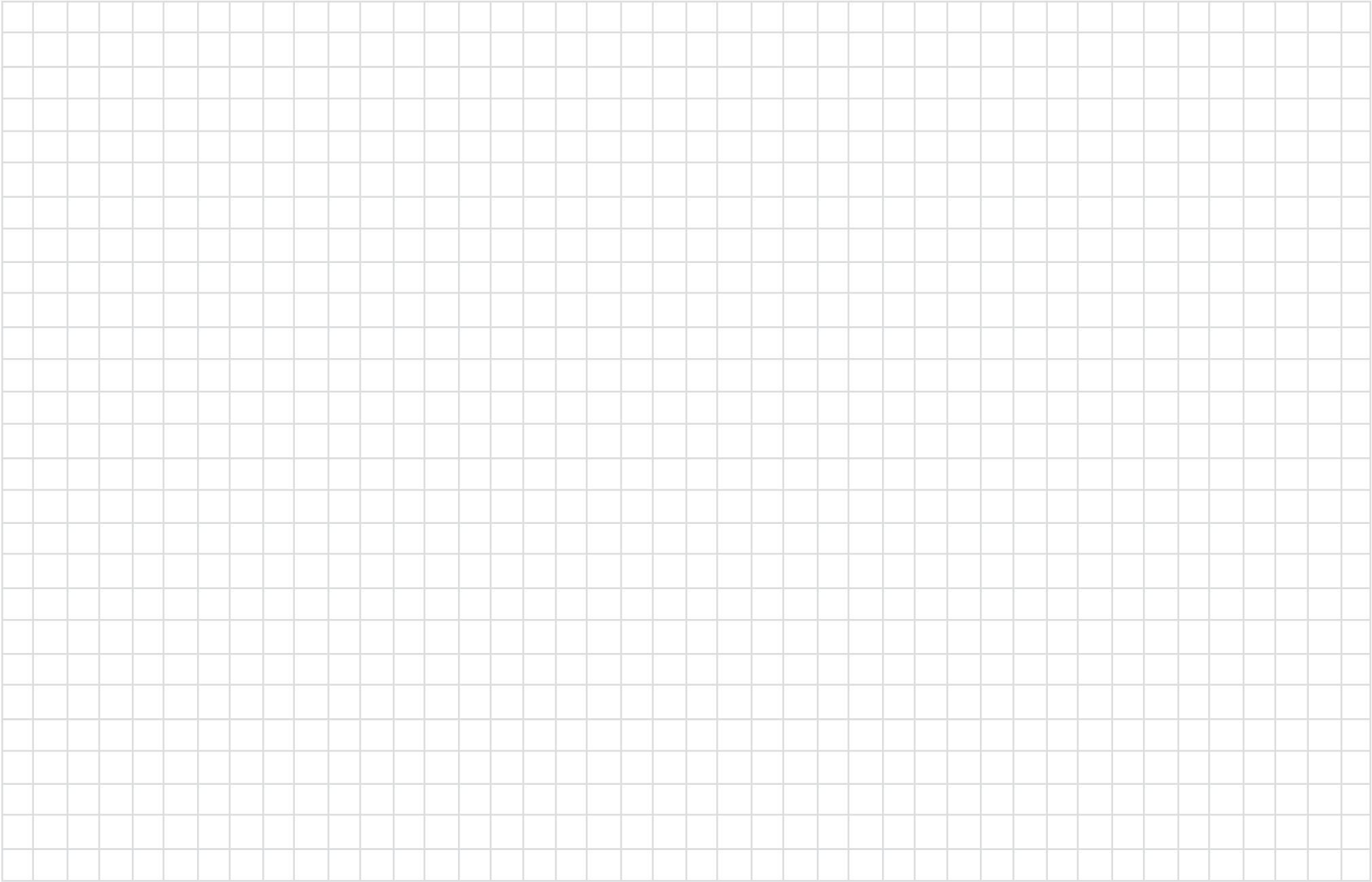



MCD550 Connections

The MCD550 has the ability to be remotely switched On/Off from a McIntosh Preamplifier or A/V Control Center via the Power Control connection. The MCD550 Data Port Connection allows for the remote operation of basic functions using the Preamplifier or A/V Control Center Remote Control. With an external sensor connected to the MCD550, remote control operation is possible from another room and/or when the MCD550 is located in a cabinet with the doors closed.

The connection instructions below, together with the MCD550 Connection Diagram located on the separate folded sheet “**Mc1A**,” is an example of a typical audio or audio/video system. Your system may vary from this, however the actual components would be connected in a similar manner. For additional information refer to “Connector and Cable Information” on page 4.

Power Control Connections:

1. Connect a Control Cable from the Preamplifier or A/V Control Center Power Control MAIN (or ACC) Jack to the POWER CONTROL IN Jack on the McIntosh MCD550 SACD/CD Player.
2. Optionally, connect a Control Cable from the MCD550 SACD/CD Player POWER CONTROL OUT Jack to the external Disc Player Power Control In Jack.
3. Optionally, connect a Control Cable from the MCD550 SACD/CD Player Power Control Out Jack to the Music Server PWR (Power) CTRL (Control) In Jack.
4. Connect any additional components in a similar manner, as outlined in steps 1 thru 3.

Data Control Connections:

5. Connect a Control Cable from the Preamplifier or A/V Control Center CD Data Port Jack to the McIntosh MCD550 SACD/CD Player DATA IN Jack.

Sensor Connections:

6. Connect an IR Sensor to the McIntosh MCD550 SACD/CD Player IR IN Jack.

Digital Audio Connections:

7. Optionally, connect a Cable from the McIntosh MCD550 SACD/CD Player DIGITAL AUDIO OUTPUT, COAXIAL or OPTICAL to the Optical or Coaxial Input on the Preamplifier or A/V Control Center.
8. Optionally, connect a Cable from the MCD550 SACD/CD Player DIGITAL AUDIO INPUT, COAXIAL to the Coaxial Output on the Disc Player.

Note: Optical connections may be used instead of the Coaxial Connections.

9. Optionally, connect a Cable from the MCD550 SACD/CD Player DIGITAL AUDIO INPUT, OPTICAL to the Optical Output on the Music Server.

Note: Coaxial connections may be used instead of the Optical Connections.

Analog Audio Connections:

10. Connect Balanced Cables from the McIntosh MCD550 SACD/CD Player FIXED AUDIO OUTPUT, BALANCED Connectors to the Preamplifier or A/V Control Center Balanced 1 Input Jacks.
11. Optionally, connect an Audio Cable from the MCD550 SACD/CD Player FIXED AUDIO OUTPUT, UNBALANCED Jacks to the Preamplifier or A/V Control Center CD Input Jacks.

Note: Preamplifiers require either a Balanced or Unbalanced audio connection. A/V Control Centers usually require unbalanced connections for proper operation of Zone B and the record output, with Balanced connections as optional.

AC Power Cords Connections:

12. Connect the McIntosh MCD550 SACD/CD Player AC Power Cord to a live AC outlet.

MCD550 Direct to a Power Amplifier Connections

The MCD550 has the ability to be connected directly to a Power Amplifier and remotely switch the amplifier and other source components On/Off via the Power Control connection. The connection instructions below, together with the MCD550 Connection Diagram located on the separate folded sheet “Mc1B, is an example of a typical audio system. Your system may vary from this, however the actual components would be connected in a similar manner. For additional information refer to “Connector and Cable Information” on page 4.

Power Control Connections:

1. Connect a Control Cable from the McIntosh MCD550 SACD/CD Player POWER CONTROL OUT Jack to the Power Amplifier Power Control INput Jack.
2. Optionally, connect a Control Cable from the Power Amplifier Power Control Out 1 Jack to the external Disc Player Power Control In Jack.
3. Optionally, connect a Control Cable from the external Disc Player Power Control Out Jack to the Music Server PWR (Power) CTRL (Control) In Jack.
4. Connect any additional components in a similar manner, as outlined in steps 1 thru 3.

Digital Audio Connections:

5. Optionally, connect a Cable from the MCD550 SACD/CD Player DIGITAL AUDIO INPUT, COAXIAL to the Coaxial Output on the Disc Player.
Note: Optical connections may be used instead of the Coaxial Connections.

6. Optionally, connect a Cable from the MCD550 SACD/CD Player DIGITAL AUDIO INPUT, OPTICAL to the Optical Output on the Music Server.
Note: Coaxial connections may be used instead of the Optical Connections.

Analog Audio Connections:

7. Connect Balanced Cables from the McIntosh MCD550 SACD/CD Player VARIABLE AUDIO OUTPUT, BALANCED Connectors to the Power Amplifier Balanced Input Connectors.
Note: The Unbalanced audio connections may be used instead of Balanced connections.

AC Power Cords Connections:

8. Connect the McIntosh MCD550 SACD/CD Player AC Power Cord to a live AC outlet.

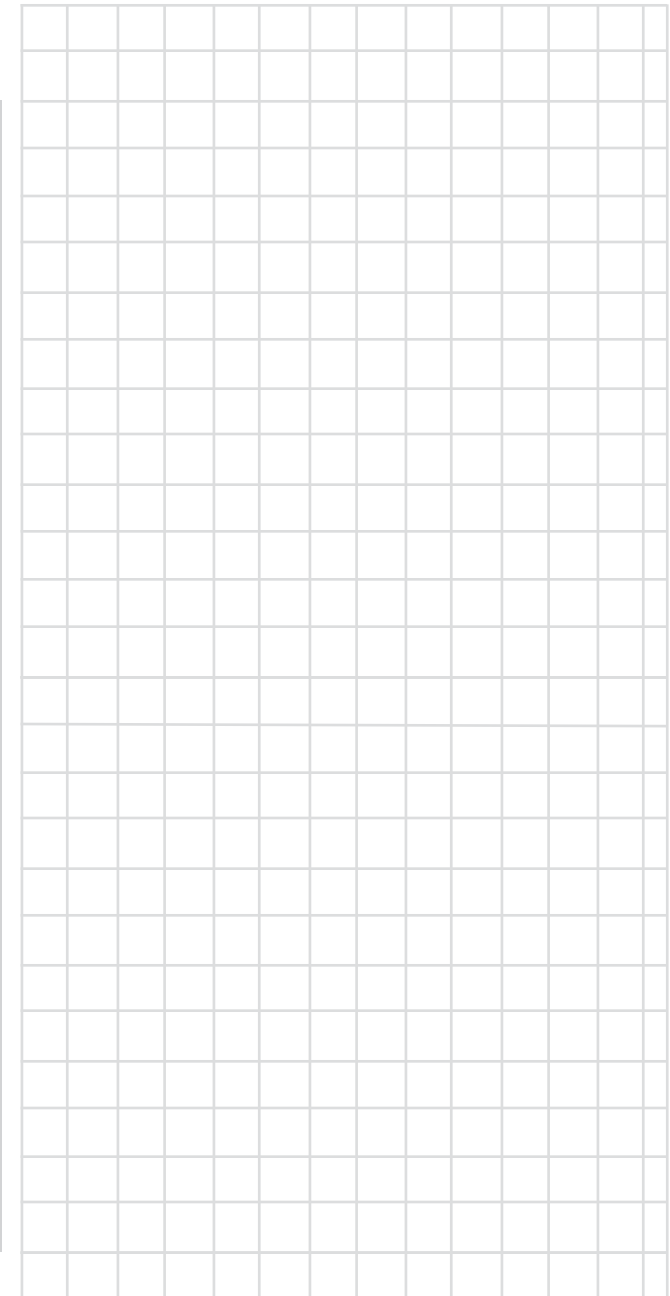

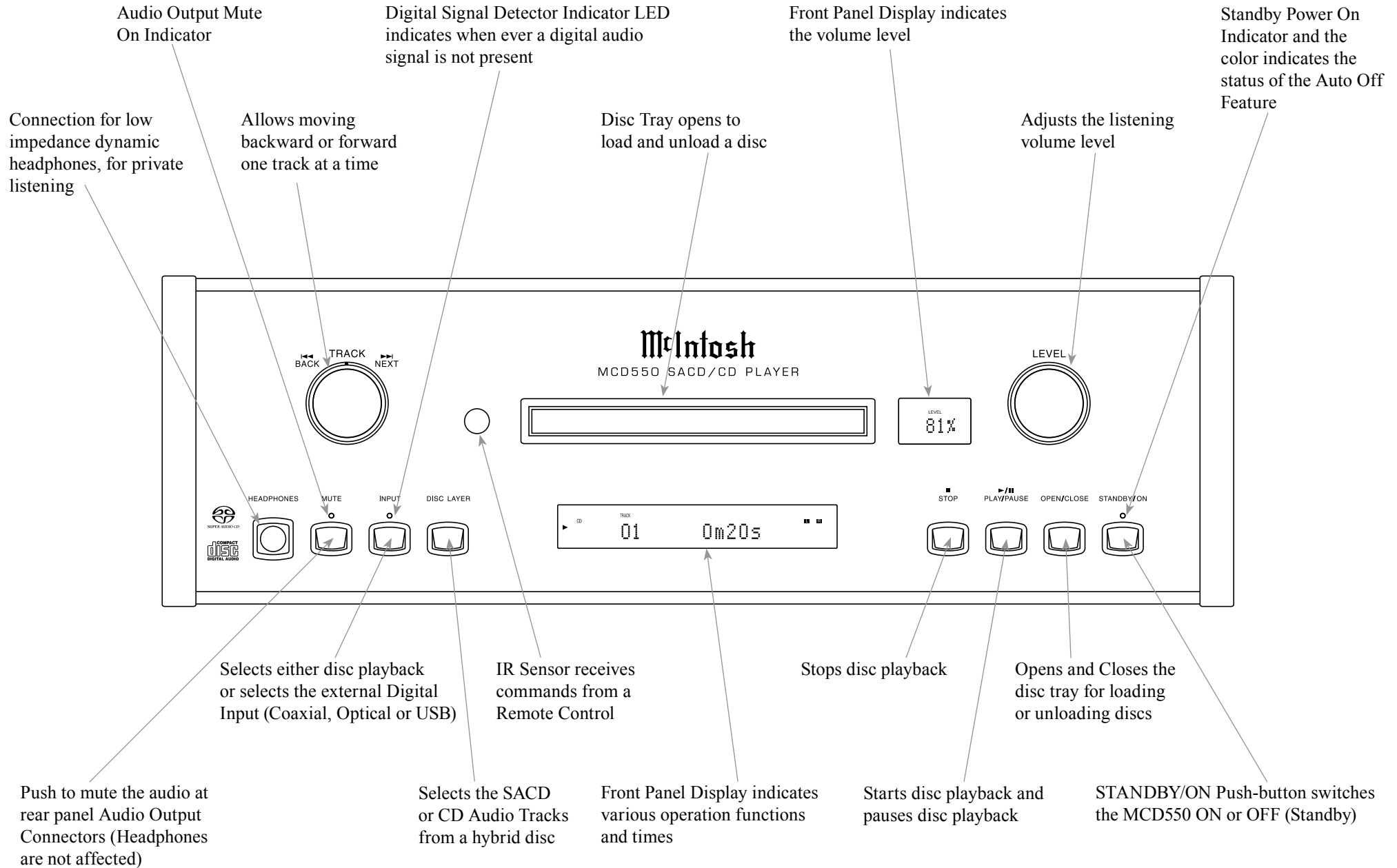

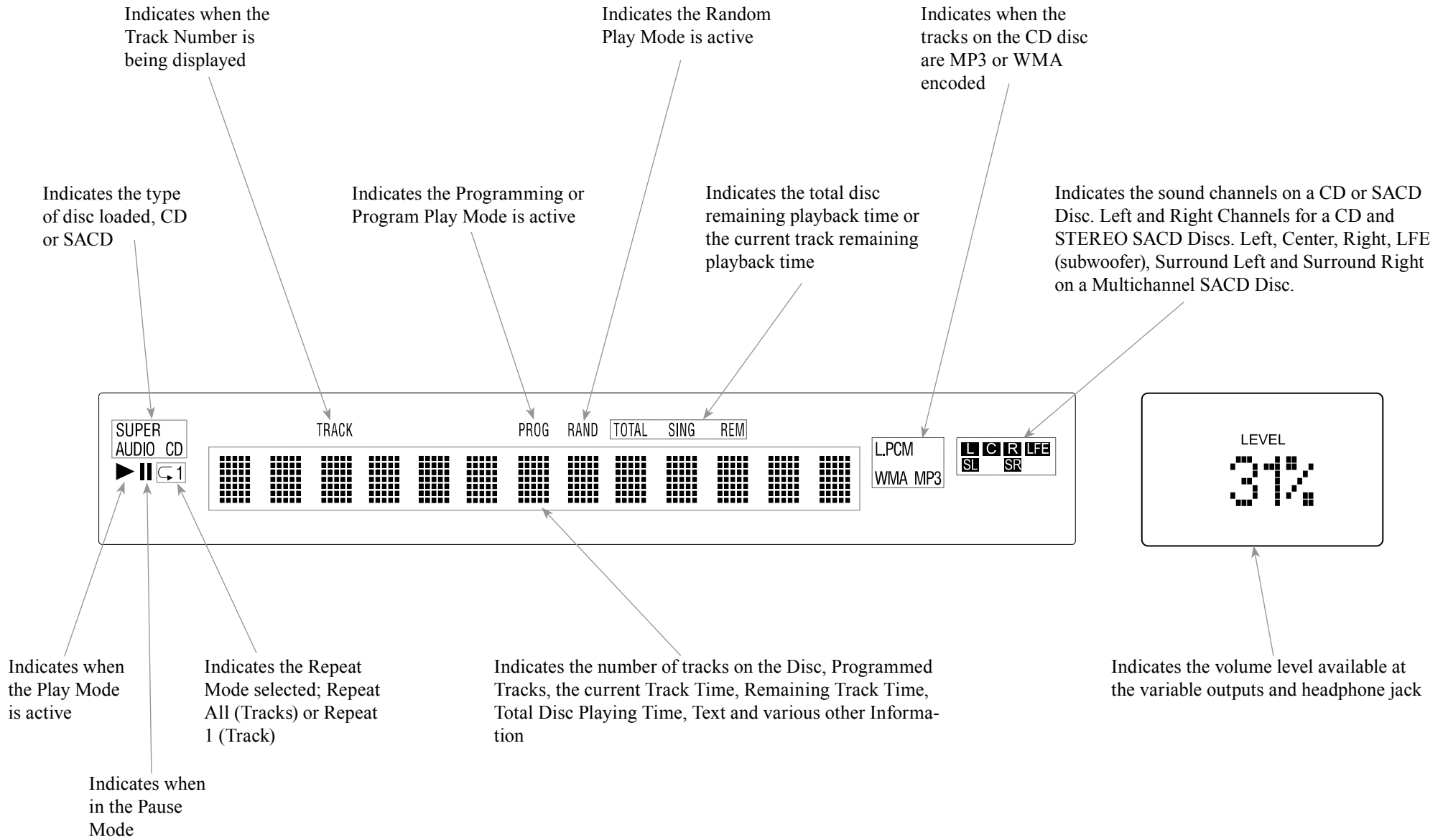



Used to activate random playback or program the desired tracks on a SACD or CD disc

Press to move backward one track at a time on SACD and CD Discs

Moves backward in time through a track

Starts playback of a disc and pauses playback

Used to stop playback of the disc

Access the Text Display Mode when playing a SACD Disc containing the information

Use to select various disc information, including time, on the Front Panel Display. It is also used to cancel the text display mode on a SACD Disc

Access any numbered operating function

Use to Clear the last programmed track

Use to select one of various repeat modes

Selects sound from MCD550 Disc Playback or the external Digital Input (Coaxial, Optical or USB)

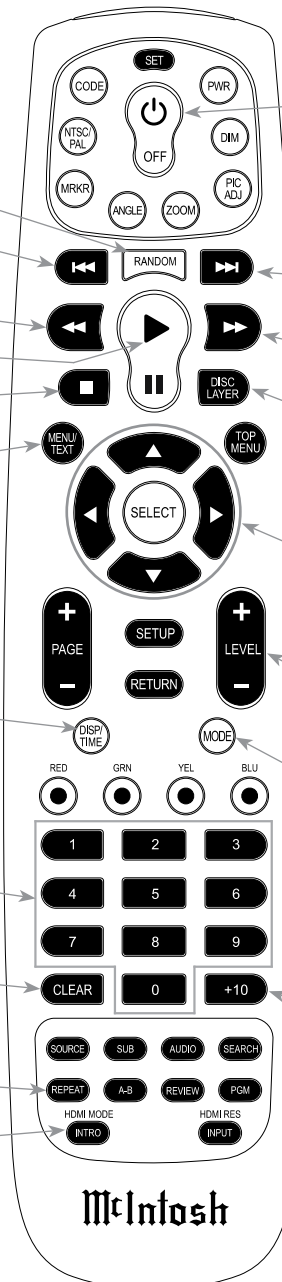

Momentarily press to Power the MCD550 ON or OFF

Press to move forward one track at a time on SACD and CD Discs. Also used to review the programmed tracks

Moves forward in time through a track

Use to select the SACD or CD Tracks from a hybrid disc for playback

Used for navigating up, down, left, right through tracks/folders; also use to select the track/folder indicated on the Front Panel Display

Adjusts the volume level up or down

Selects Disc Mode or Folder Mode for navigating and selection of music on a CD-ROM Disc

Use to direct access tracks 10 and above

Note: The Remote Control Push-buttons not identified are for use with other McIntosh Products

How to use the Remote Control

The Remote Control is capable of performing most Operating Functions for the MCD550 SACD/CD Player.

Note: Refer to the "How to Operate" Section of this manual for additional information using this Remote Control.

Play

With a disc loaded, press the PLAY ► Push-button to start the disc playing. Press the PLAY ► Push-button a second time to temporarily stop disc playback at any time (Pause).

Note: The Play and Pause Push-buttons have been combined into a single rocker type push-button. Press the upper portion where the ► symbol is for playback and for pausing the playback of a disc.

Stop

Press the STOP ■ Push-button to stop disc playback and return to displaying the table of contents of the disc.

Numbered Push-buttons

Press 1 through 9 to directly access one of the first nine Disc Tracks using the Front Panel Information Display. For track numbers greater than 10, press the +10 Push-button followed by the 0-9 Push-button. For example, to access Disc Track 23, press the +10 Push-button twice and then the 3 Push-button.

Reverse and Fast Forward

Press the ◀◀ (Reverse) or ▶▶ (Fast Forward) Push-button to start moving rapidly through a track on the disc. When the desired location is reached release the ◀◀ (Reverse) or ▶▶ (Fast Forward) Push-button to resume normal playback.

Back and Next

Press the ▶▶ (Next) Push-button to move forward one track or the ◀◀ (Back) Push-button to move back to the beginning of the current track playing. Also used to review the Programmed Tracks from the disc on the Front Panel Information Display, while in the Program Mode.

Note: If the ◀◀ (Back) Push-button is pressed during playback of the first three seconds of the track, the MCD550 will start playing back the previous track from the beginning. If the Front Panel Information Display is indicating time, the display will momentarily indicate the track number.

SACD or CD Track Selection

Press the DISC LAYER Push-button to select the SACD or CD Tracks from a hybrid disc for playback.

Display/Time

Press the DISPlay/TIME Push-button to access various disc times. It is also used to return the Front Panel Information Display to indicating time instead of text information on a SACD Disc.

Menu/Text

Press the MENU/TEXT Push-button to select the various text information on a SACD Disc such as Album, Artist and Track Titles (disc dependent).

Repeat Modes

Press the REPEAT Push-button to select either One Track, All Tracks or cancel the Repeat Mode.

Clear

Press the CLEAR Push-button to erase a program track(s).

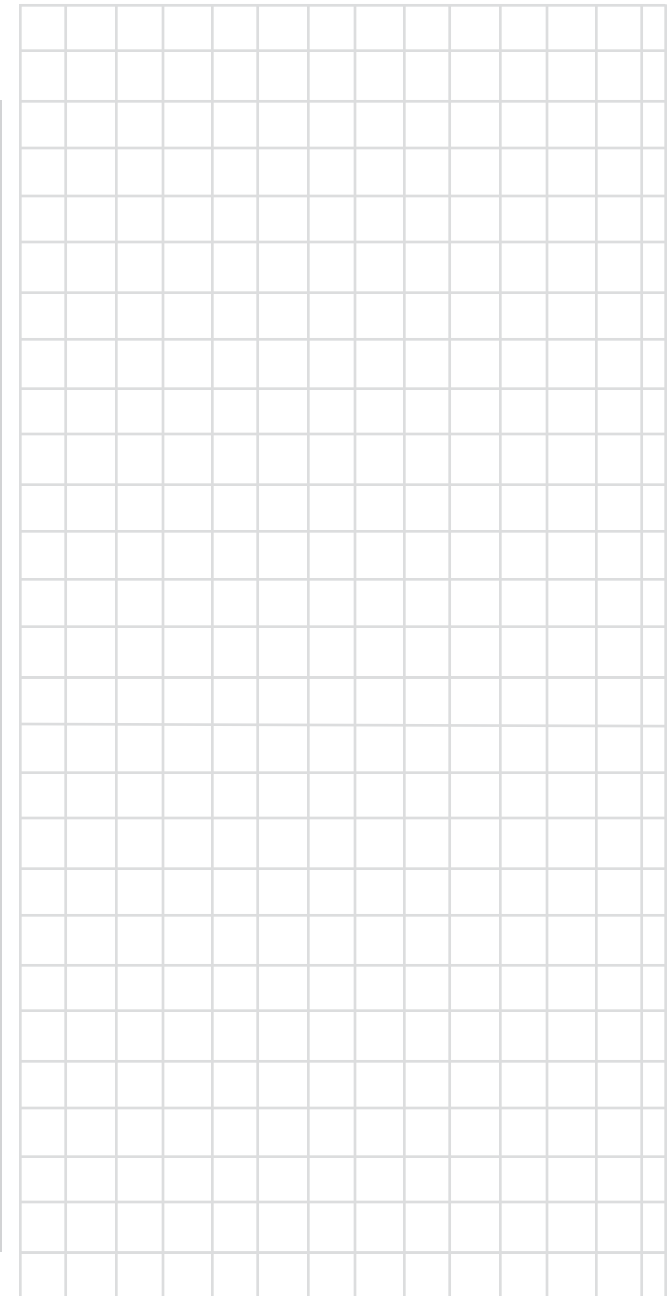



How to Operate the MCD550

Power On and Off

The LED above the STANDBY/ON Push-button lights to indicate the MCD550 is connected to AC Power. Refer to figure 1. The LED also indicates the status of the Auto Off Feature. When the MCD550 is in the Standby Mode, green illumination indicates the Auto Off Feature is enabled (default setting) and red illumination indicates the Auto Off Feature is disabled. For additional information refer to “Auto Off Mode” on page 21.

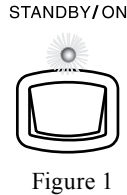



Figure 1

Note: When AC Power is initially applied to the MCD550, the unit will momentarily switch On and then go into the Standby Mode.

To Switch ON the MCD550, momentarily press the STANDBY/ON Push-button on the Front Panel or the  (Power) Push-button on the Remote Control. Refer to figures 2 and 21. The LED above the STANDBY/ON Push-button illuminates green. LEDs above the MUTE and INPUT Push-buttons will illuminate. The Front Panel Display will momentarily indicate “DISC” followed by “READING” and then “NO DISC”. Refer to figures 2, 3, 4, 5 and 21. To switch OFF the MCD550, momentarily press the STANDBY/

ON Push-button on the Front Panel or the OFF Push-button on the Remote Control.

DISC READING NO DISC

Figure 3

Figure 4

Figure 5

How to Load and Unload a Disc

1. Press the OPEN/CLOSE Push-button. The disc tray will slide out allowing a CD Disc to be loaded. Refer to figure 6.
2. Press the OPEN/CLOSE Push-button and the disc tray will close. Refer to figure 7. Loading of the CD Disc’s Table of Contents (number of tracks and total playing time) will be indicated on the Front Panel Display. Refer to figure 8.

OPEN

Figure 6

CLOSE

Figure 7

Note: When a Disc is placed in the tray and the PLAY/PAUSE Push-button is pressed, the tray will close and the first track will start playing.

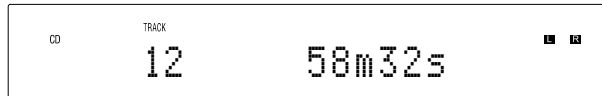

Figure 8

3. Pressing the OPEN/CLOSE Push-button will stop playback of the disc and the disc tray will open.



Figure 2

How to Play a SACD Disc

Load a SACD Disc into the MCD550. The Front Panel Display will first scroll the Album Title of the SACD Disc (available on most SACD Discs). Refer to figures 9, 10 and 11.



Figure 9

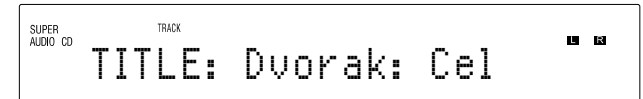

Figure 10

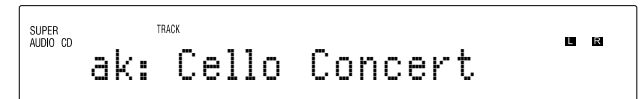

Figure 11

The Album Title is followed by the Table of Contents. Refer to figure 12.

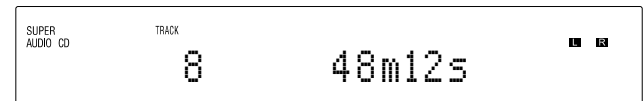



Figure 12

Press the PLAY/PAUSE  /  Push-button on the Front Panel of the MCD550 or Remote Control. Refer to figures 2 and 21. The Disc will start playing the first track of the SACD Layer.

Note: The default setting for SACD/CD Hybrid Disc is to play the SACD Stereo Layer. The default setting may be changed to play the CD Layer or the SACD Multichannel Layer, when available. With the MCD550 On and no disc loaded, press the DISC LAYER Push-button until the Front Panel Display indicates the desired layer.

Selection of a different Layer (CD, Stereo or Multichannel) can occur during playback of a disc by pressing the DISK LAYER Push-button once to see the current selection and a second or third time to select the desired Layer. Refer to figures 13, 14 and 15. The Player will stop playing the current Layer and then load the desired Layers' Table of Contents (Number of tracks and Total Playing Time). Once the information is indicated on the front panel display, press the PLAY/PAUSE ►/|| Push-button. Refer to figure 16.

STEREO

Figure 13

MULTI

Figure 14

CD

Figure 15

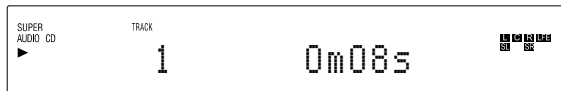

Figure 16

Note: 1. Most SACD Disc(s) have the ability of displaying the Album Title and Artist. With the disc loaded, SACD Table of Contents read and the disc stopped, press the MENU/TEXT Push-button once for scrolling the Title and twice for scrolling the Artist Name. Display of the Artist information is not available during playback of the disc. Refer to figures 17, 18 and 21.

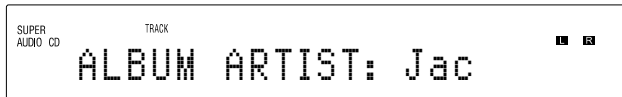

Figure 17

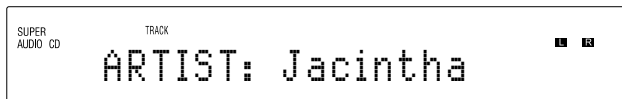

Figure 18

2. In a similar manner, some SACD Discs have the ability of scrolling the Track Number and Title by pressing the MENU/TEXT Push-but-

ton after the Track has started to play. Refer to figures 19 and 21.

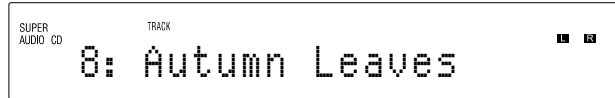

Figure 19

3. The Text Display Mode may be canceled by pressing the DISP/TIME Push-button on the Remote Control. Refer to figure 21.
4. The various Time Modes may be displayed by pressing the DISP/TIME Push-button on the Remote Control. Refer to figure 21. For additional information on the Time Display Modes refer to "Display Modes" on page 20.
5. SACD Discs containing Multichannel sound tracks are down mixed into two channels and available at the Analog Audio Outputs.

How to Play a CD Disc

With a disc already loaded into the MCD550, press the PLAY/PAUSE ►/|| Push-button on the Front Panel of the MCD550 or Remote Control. Refer to figures 2, 20 and 21.

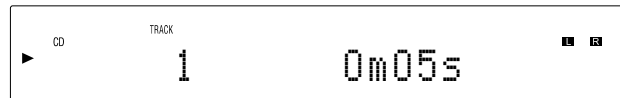

Figure 20

How to Pause a Disc

This feature allows for the temporary stopping of disc playback. Refer to figures 2, and 16.

1. When playing a Disc, press the PLAY/PAUSE ►/|| Push-button to temporarily stop playback.
2. Press the PLAY/PAUSE ►/|| Push-button to resume playing the disc.

Track Back

Return to the beginning of the Track currently playing by rotating the MCD550 Front Panel TRACK BACK ◀◀ Control counterclockwise and then releasing the control or momentarily pressing the ◀◀ Push-button on the Remote Control. Rotate and hold the TRACK BACK ◀◀ Control or press and hold the ◀◀ Push-button on the Remote Control for rapid selection of the desired previous Tracks. Refer to figures 2 and 21.

Track Next

Advance to the next Track by rotating the MCD550 Front Panel TRACK NEXT ▶▶ Control clockwise and then releasing the control or momentarily pressing the ▶▶ Push-button on the Remote Control. Rotate and hold the TRACK NEXT ▶▶ Control or press and hold the ▶▶ Push-button on the Remote Control for rapid selection of the next desired Track. Refer to figures 2 and 21.

Fast Forward or Reverse

Using the Remote Control, press the ▶▶ (Fast Forward) or ◀◀ (Reverse) Push-button to search back and forth rapidly through a Track on a disc. To return to normal

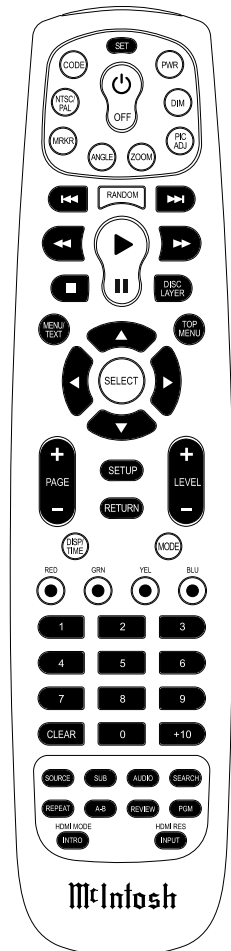

Figure 21



How to Operate the MCD550, con't

playback release the same ►► (Fast Forward) or ◀◀ (Reverse) Push-button. Refer to figure 21.

Stop Mode

Press the STOP ■ Push-button at any time to stop Playback. To listen to the disc again, press the PLAY/ PAUSE ►/ || Push-button and playback will start from the beginning of the disc.

Volume Level

The MCD550 has both Fixed and Variable Output Level Connections. The Variable Output Level Connections (Rear Panel and Front Panel Headphone Jack) are controlled by the Front Panel LEVEL Control and the LEVEL (+/-) Push-button on the Remote Control. Refer to figures 2, 22 and 25. The Front Panel Volume Level Information Display will indicate the Volume Level from 0 - 100%.



Figure 22

Note: When the Volume Level is 76%, the Rear Panel Variable Outputs will be at the same volume level as the Fixed Outputs.

Mute

Press the MUTE Push-button to mute the audio (-50dB down in level) at both the Fixed and Variable Output Connections on the Rear Panel. Refer to figure 2. The LED above the MUTE Push-button will illuminate. Pressing the MUTE Push-button a second time restores the audio at the output connections and the LED will no longer be illuminated.

Note: The Headphone Jack is not affected by the Mute Function.

Direct Track Selection

The MCD550 Front Panel Display indicates the Disc Track currently playing. Use the Remote Control NUMERIC Push-button(s) to enter the desired Track Number. Refer to pages 14 and 15 for additional information using the Remote Control.

Repeat

This allows repeating a Track, Disc, Program Mode or Random Play Mode on a continuous basis. Refer to figures 2 and 25.



Figure 2

1. With the disc playing (Regular, Program or Random Playback Modes), press the REPEAT Push-button once to activate the Track Repeat (◁1); press the REPEAT Push-button twice to activate the Disc Repeat (◁). Refer to figures 23 and 24.

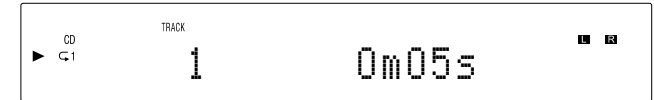

Figure 23

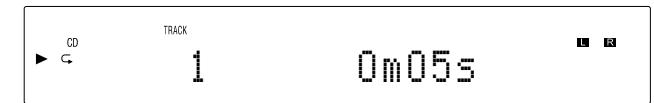

Figure 24

2. To cancel the previously selected Repeat Mode, press the REPEAT Push-button until the character "1" and/or the symbol "◁" in the Front Panel Information Display is extinguished.

Random Playback

This feature allows for listening to Tracks of a Disc in a Random Order. Refer to figure 25.

Note: Before the Random Playback Mode feature on the MCD550 can be activated, the disc must be stopped or the message "Press ■ (stop) first" will momentarily appear on the Front Panel Display. Refer to figure 26.

1. With the MCD550 in the STOP ■ Mode press the RANDOM Push-button. The word RANDOM will be indicated in

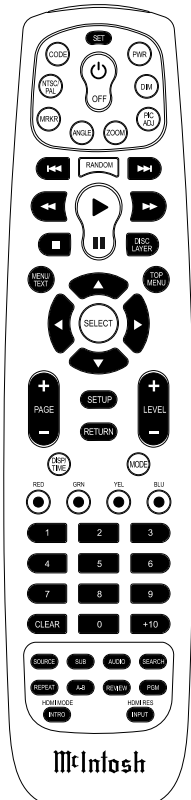

Figure 25

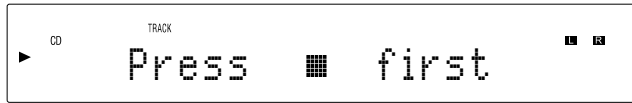

Figure 26

the Front Panel Display. Refer to figure 27.

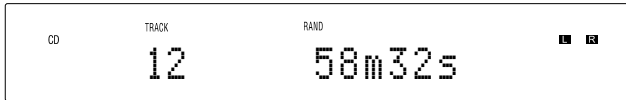

Figure 27

2. Press the PLAY/PAUSE ►/ || Push-button to start Random Playback. After all the tracks have been played the MCD550 will stop.

Notes: 1. To provide continuous playback of the disc, press the REPEAT Push-button twice to activate the Disc Repeat (Ⓢ) after the Random Playback Mode has started. If Repeat (Ⓢ) is selected, the current track will repeat.

2. The NEXT TRACK ►► function will advance to the next random selection and start playing.

3. To cancel the Random Playback Mode, press the STOP ■ Push-button, then press the RANDOM Push-button twice.

Program Playback

This feature allows for playback of selected Tracks on a Disc in the desired order. In the following example, a Disc is programmed to play Track 6 followed by Track 4 and then Track 2.

Notes: 1. The MCD550 must be in STOP Mode with the Disc TOC (Table of Contents) read before the Program Playback Mode Feature can be activated.

2. When programming Hybrid SACD Discs, first choose the layer (SACD or CD) so the correct

TOC can be read, as some discs have different selections for the SACD and CD Tracks.

1. Press the RANDOM Push-button twice to access the Program Mode. Refer to figures 2, 25 and 28.

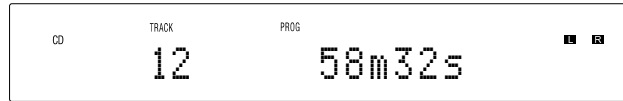

Figure 28

2. Enter the first desired selection (track 6) using the Numeric Push-buttons. The Front Panel Display will first indicate track 6 followed by indicating the total number of tracks and total playback time for the current program. Refer to figures 29 and 30.

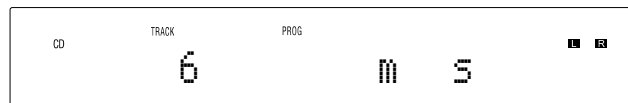

Figure 29

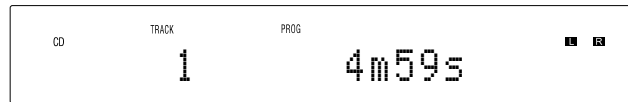

Figure 30

3. In a similar manner, enter the remaining Tracks 4 and 2. Refer to figures 31 thru 34.

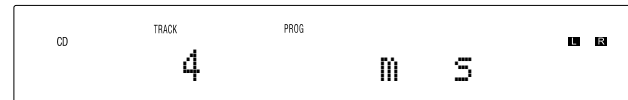

Figure 31

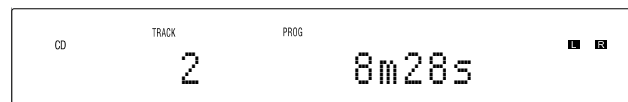

Figure 32

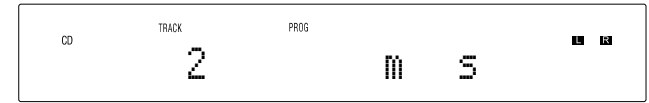

Figure 33

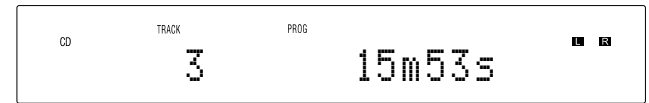

Figure 34

Note: To view and/or delete the selections programmed, use the TRACK NEXT ►► Push-button to step through programmed tracks and the CLEAR Push-button to remove any unwanted selections.

4. To start playback of the just entered program, press the PLAY/PAUSE ►/ || Push-button. Refer to figure 35.

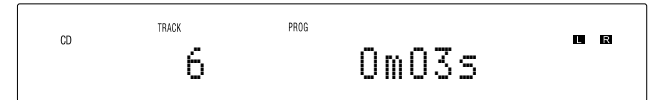

Figure 35

After playback begins, the Repeat Mode can be activated to provide continuous playback of the Programmed Track(s). Refer to figure 25.

Note: To momentarily stop playback, press the PLAY/PAUSE ►/ || Push-button. To resume Program Playback press the PLAY/PAUSE ►/ || Push-button.

5. To cancel the Program Playback Mode, press the STOP ■ Push-button followed by pressing the RANDOM Push-button.

Once the Program Playback Mode is active, tracks may be added or deleted by first pressing the STOP ■ Push-button followed by entering the additional tracks using the Numeric Push-buttons or delete the last track programmed by using the CLEAR Push-button.



How to Operate the MCD550, con't

MP3/WMA Disc Playback

The MCD550 has the ability of playing back MP3 and WMA encoded discs. MP3 and some version of WMA coding allow more tracks on the Disc by using the technique of lossy compression applied to the original audio information. These Tracks have lower audio quality than the original recording. Load a MP3/WMA disc into the MCD550. Refer to figure 36.



Figure 36

The MCD550 has two MP3/WMA Modes of Operation: Disc Mode and Folder Mode. Refer to figures 37 and 38. Select the desired mode by pressing the MODE Push-button on the Remote Control.

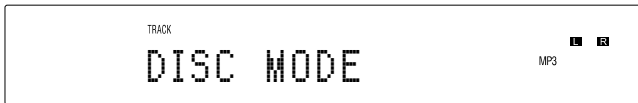

Figure 37

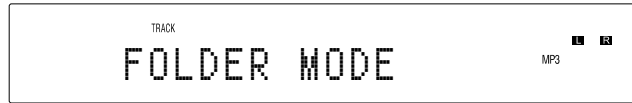

Figure 38

The Disc Mode will play back all the tracks on the disc starting with tracks not in folders first, followed by the track contained in the folder second. The Folder Mode will playback the tracks contained in the selected folder. Refer to figure 39.



Figure 39

1. Press the PLAY/PAUSE ►/|| Push-button to start Playback. Refer to figure 40.

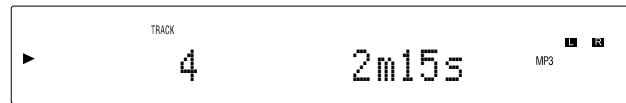

Figure 40

After all the tracks have been played the MCD550 will stop.

Note: Use the ▲ up and ▼ down directional Push-buttons to select folders on the disc.



Figure 2

Display Modes

The MCD550 Front Panel Display indicates both track number and playing time. There are three playing time display indications: track elapse time, track remaining time or disc remaining time. To change from the default setting of track elapse time, press the DSP/TIME Push-button on the Remote Control. Refer to figures 25, 41, 42 and 43.

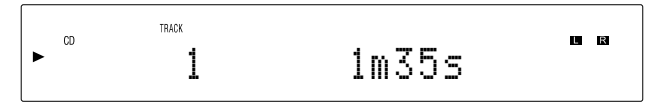

Figure 41

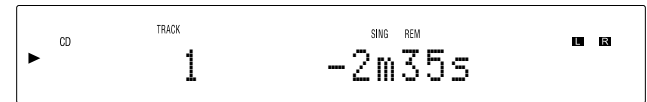

Figure 42

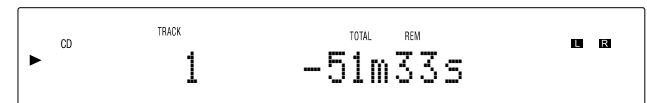

Figure 43

Display Brightness

There are three available brightness settings for the MCD550 Front Panel Displays: high (default setting), medium or low. To change the brightness setting perform the following steps and refer to figure 2:

1. Remove any disc from the MCD550 Disc Tray.
2. Press the STAND/BY Push Button to switch power OFF to the MCD550.
3. Press and hold in the MUTE Push-Button.
4. Press the STAND/BY Push-Button to switch power ON to the MCD550.
5. Release the MUTE Push-button, the LED above the MUTE Push-button will now be illuminated.
6. To change the current brightness setting, momentarily press the MUTE Push-button for the next brightness setting (high, medium or low). Repeat

- this until the desired brightness setting is selected.
- Press the DISC LAYER Push-button to store the new brightness setting. The LED above the MUTE Push-button will now extinguish.

Power Mode

The MCD550 incorporates an Auto Off Feature, which can automatically place the SACD/CD Player into the Power Saving Standby/Off Mode (default setting). This occurs approximately 30 minutes after there has been an absence of a Digital Audio Signal. This includes a Digital Audio Signal coming from Disc Playback, Optical/Coaxial Input Signal or an USB Input Signal. If it is desirable to disable the Auto Off Feature, perform the following steps:

- Using the MCD550 Remote Control, press and hold in the (Power) Push-button for about 5-10 seconds, at which time the Front Panel Display indicates “Auto STBY Off”. Refer to figure 44.



Figure 44

- The MCD550 will switch Off and the LED above the STAND/BY Push-button will illuminate Red in color. Press the (Power) Push-button to switch the MCD550 On.
- To re-activate the Auto Off Feature, press and hold in the Power Push-button on the Remote Control for about 5-10 seconds, at which time the Front Panel Display indicates “Auto STBY On”. Refer to figure 45.

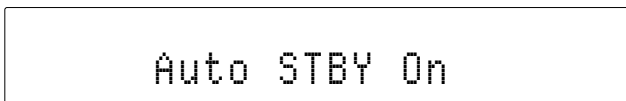

Figure 45

- The MCD550 will switch Off and the LED above the STAND/BY Push-button will illuminate Green in color. Press the (Power) Push-button to switch the MCD550 On.

External Digital Inputs

The MCD550 internal D/A (Digital to Analog) Converter may be used to decode a variety of Digital Audio Signals. It will decode a two channel PCM Encoded Digital Signal into a two channel Analog Signal. There are connections for Coaxial, Optical, and USB Digital Inputs. They may be connected simultaneously and the MCD550 has electronic switching for selection of the desired music source.

The default Digital Input Selection is DISC for playback of a disc. To select an external Digital Input press the INPUT Push-button on the Front Panel or press the INTRO (HDMI) Push-button on the MCD550 Remote Control repeatedly until the name of the desired Input appears on the Front Panel Information Display. Refer to figures 46, 47, 48, 49 and 50.

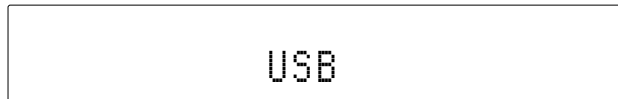

Figure 46



Figure 47

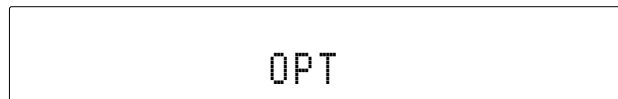

Figure 48

When a Digital Audio Signal is not present on the selected External Digital Input, the Front Panel Display will flash the input name. Once a Digital Audio



Figure 49



Figure 50

Signal is received the Front Panel Display will indicate the sample rate of the signal. Refer to figure 50.

USB Input Operation with a Computer

The MCD550 USB Input provides the capability to playback music from a computer, when the computer is connected to the rear panel USB Digital Audio Input Connector. The MCD550 USB Input is compatible with both PC Computers using Microsoft® Windows® (XP [SP 3], Vista [SP 1], Windows 7[SP1] and Windows 8) and the Apple® Macintosh® Computers using OS-10.6 with the latest update.

When using a PC Computer with Windows or an Apple® Macintosh®, a special McIntosh USB Audio Software Driver B needs to be installed on the Computer before connecting the MCD550 USB Input to an USB Port on the computer.

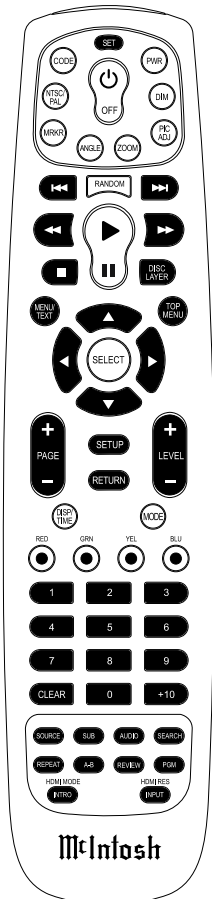

Figure 25

How to Operate the MCD550, con't

The McIntosh USB Audio Driver along with the Installation and Operation Guide are available for download from the McIntosh Web Site:

<http://www.mcintosh-labs.com/us/support/Pages/Manuals.aspx>

Under “Product Category” select Sources and under “Model Number” select MCD550, then click on “Select”. When the MCD550

Information appears, download the “McIntosh Audio Windows Driver B Installation and Operation Guide” or the “McIntosh Audio Apple Macintosh Driver B Installation and Operation Guide”. Also download “McIntosh USB Audio Windows Driver B Version _._” or the “McIntosh USB Audio Apple Macintosh Driver B Version _._”.

Follow the instructions in the Guide and after the USB Driver B is installed, connect the MCD550 to the Computer.

Note: When computer application programs and various computer hardware components conform to the Microsoft® Windows® and Apple® Macintosh® standards they should also work well when used in conjunction with the MCD550 USB Input. If you are experiencing difficulty with a specific computer hardware component or computer application program, contact the manufacturer of the product.

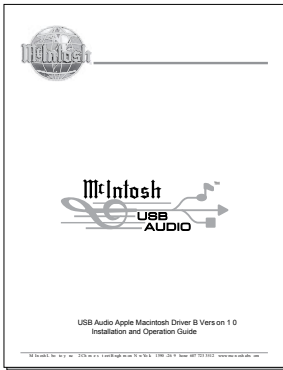
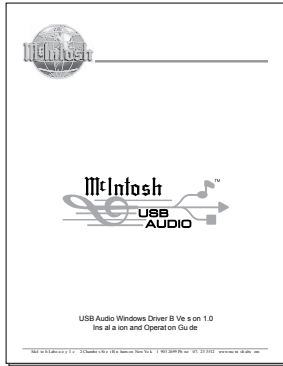

Resetting the MCD550

In the unlikely event the MCD550 stops functioning, first try resetting the Main (System) microprocessor by performing the following:

1. Simultaneously press and hold in the Front Panel MUTE and DISC LAYER Push-buttons until the illumination of the LED above the STAND/BY Push-button goes Off. The MCD550 will then switch Off.
2. Press the STAND/BY Push-button to switch the MCD550 back On.

If the MCD550 is still not functioning properly, reset the Secondary (Transport) microprocessor by performing the following:

1. Switch Off A.C. Power going to the MCD550.

Note: Temporarily, connect the AC Power Cord coming from the MCD550 into an AC Power Strip with an On/Off Switch. Position the AC Power Strip so the On/Off Switch on the strip is in very close proximity to the MCD550 Front Panel STOP Push-button (the MCD550 Remote Control STOP Push-button will not work for resetting the micro).

2. Rotate the Track Control Knob clockwise to the NEXT Track and hold the position, then press and hold in the STOP ■ Push-button while at the same time switching On the AC Power Strip.
3. The Front Panel will indicate “RESET” and then go through the process of reading the Disc for playback. At this time release the TRACK Control and the STOP ■ Push-button.
4. The MCD550 will resume normal operation.











Audio Specifications

Disc Formats

CD, SACD, MP3 and WMA

Fixed Output level

2.0Vrms Unbalanced

4.0Vrms Balanced

Variable Output level

0 - 8.0Vrms Unbalanced

0- 16.0Vrms Balanced

Output Impedance

600 ohms Unbalanced and Balanced

Frequency Response

4Hz to 40,000Hz, +0.5, -2dB (SACD)

4Hz to 20,000Hz, ±0.5dB (CD)

Signal to Noise Ratio

Better than 110dB (A-weighted)

Dynamic Range

Better than 100dB

Harmonic Distortion

0.002% @ 1000Hz (SACD)

0.002% @ 1000Hz (CD)

Channel Separation

Better than 98dB (1,000Hz)

Headphone Output Impedance

47 ohms

Headphone Load Impedance

16-600 ohms

Digital Audio Specifications

Digital Input Format

SPDIF (PCM¹)

Digital Input Sample Rate

Coaxial: 16, 24-Bit/96kHz

Optical: 16, 24-Bit/192kHz

USB: 16, 24-Bit/192kHz

Digital Inputs

Coaxial: 0.5V p-p/75 ohms

Optical: - 15dbm to -21dbm (TOS Link)

USB: USB Type B Connector

Digital Output Format

SPDIF (PCM¹)

Digital Output Sample Rate

Up to 24-Bit/192kHz

Digital Output

Coaxial: 0.5V p-p/75 ohms

Optical: - 15dbm to -21dbm (TOS Link)

¹ PCM (Pulse Code Modulation) Digital Signal type used for CD Discs

General Specifications

Transport

Laser Type: Twin Beam

Laser Beam Wavelength: 650nm (SACD)/790nm (CD)

Laser Power: CLASS IIa/CLASS I

Power Requirements

100 Volts, 50/60Hz at 35 watts

110 Volts, 50/60Hz at 35 watts

120 Volts, 50/60Hz at 35 watts

220 Volts, 50/60Hz at 35 watts

230 Volts, 50/60Hz at 35 watts

240 Volts, 50/60Hz at 35 watts

Standby: Less than 0.5 watt

Note: Refer to the rear panel of the MCD550 for the correct voltage.

Overall Dimensions

Width is 17-1/2 inches (44.4cm)

Height is 6 inches (15.2cm)

Depth is 19 inches (48.3cm) including the Front Panel, Knobs and Cables

Note: When the Disc Tray is opened, the panel clearance required in front of mounting panel is 6-3/4 inches (17.2cm).

Weight

28 pounds (12.7Kg) net, 42.5 pounds (19.2Kg) in shipping carton

Shipping Carton Dimensions

Width is 26-1/2 inches (67.3cm)

Depth is 24-1/4 inches (62.2cm)

Height is 11-3/4 inches (29.9cm)

Packing Instructions

In the event it is necessary to repack the equipment for shipment, the equipment must be packed exactly as shown below. It is very important that the four plastic feet are attached to the bottom of the equipment. This will ensure the proper equipment location on the bottom pad. Failure to do this will result in shipping damage.

Use the original shipping carton and interior parts only if they are all in good serviceable condition. If a shipping carton or any of the interior part(s) are needed, please call or write Customer Service Department of McIntosh Laboratory. Refer to page 4. Please see the Part List for the correct part numbers.

Quantity	Part Number	Description
1	033838	Shipping carton only
4	033837	End cap
1	033836	Inside carton only
1	034414	Top pad
1	034301	Bottom pad
2	034446	Foam plug
4	017937	Plastic foot
4	400159	#10-32 x 3/4" screw
4	404080	#10 Flat washer

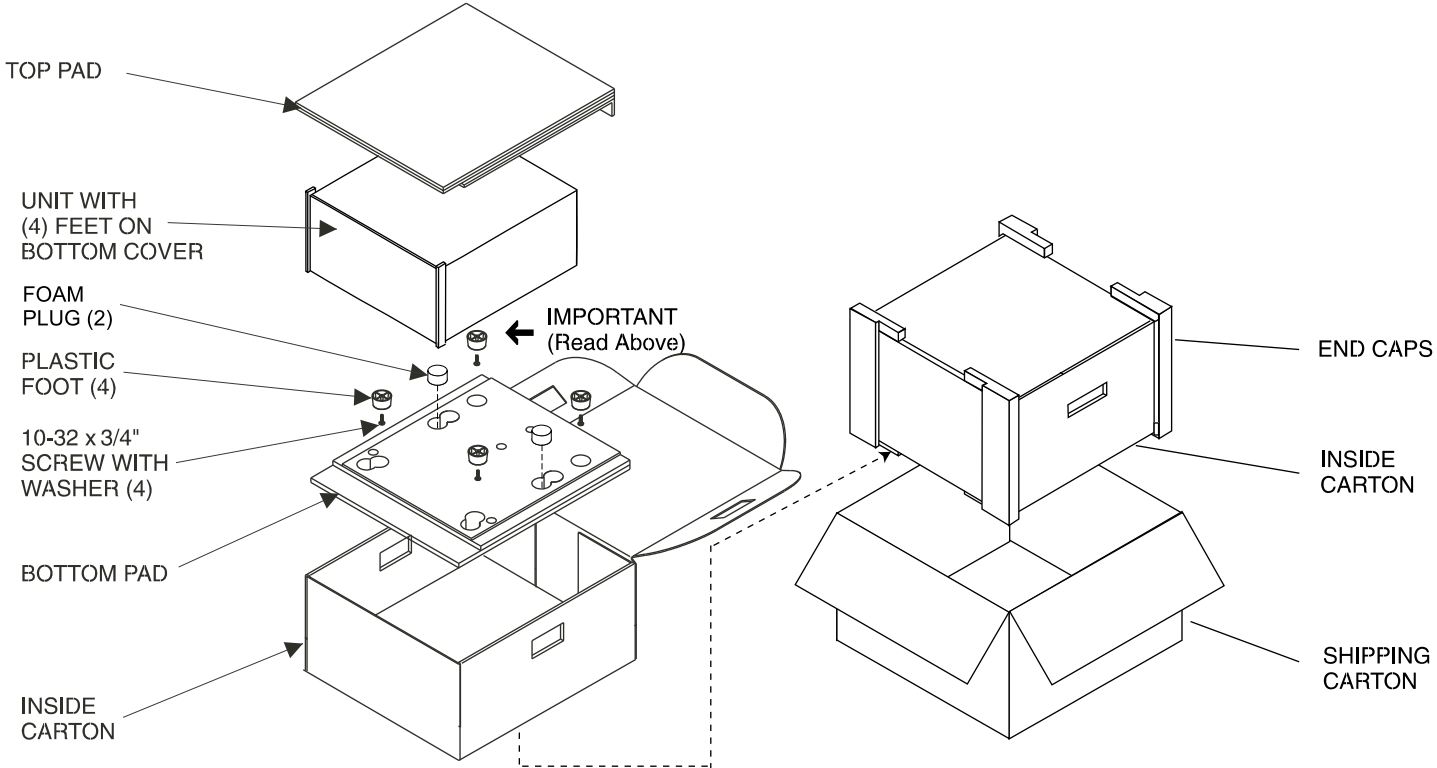



McIntosh Laboratory, Inc.
2 Chambers Street
Binghamton, NY 13903
www.mcintoshlabs.com

The continuous improvement of its products is the policy of McIntosh Laboratory Incorporated who reserve the right to improve design without notice.
Printed in the U.S.A.